

PROFESSIONAL MOVING HEADS



# GIOTTO 400 S E R I E S



 **SGM**<sup>®</sup>  
*Technology for Lighting*



Operational versatility is the strong point of **GIOTTO 400 SERIES**: compact but capable of great performance, GIOTTOs 400 have all the functions that make lighting ops' and designers' work more productive, more creative and easier. GIOTTOs 400 are fitted with a 400W discharge lamp, used along with an optical group that gives extraordinary luminous power. The electronic ballast ensures bright flicker-free light.

The motorized zoom gives beam angles otherwise only obtainable with more expensive fixtures. Movement, internal mechanism and ventilation guarantee absolute silence, ideal for theatre and television use.



## G I O T T O 4 0 0 S E R I E S

The GIOTTOs 400 ensure maximum flexibility in any situation and is adapt to any use.

**Compactness and light weight**, the four models can be easily transported and installed by a single operator, thanks to their practical handles and 'Fast Lock' hanging clamps.

**User-friendly maintenance** is ensured by facilitated head opening and easy access to internal components; relamping can be done extremely rapidly without moving the lamp holder.

The **electronic ballast** enables the fixture to be used with any power supply (90-245V / 50/60 Hz).

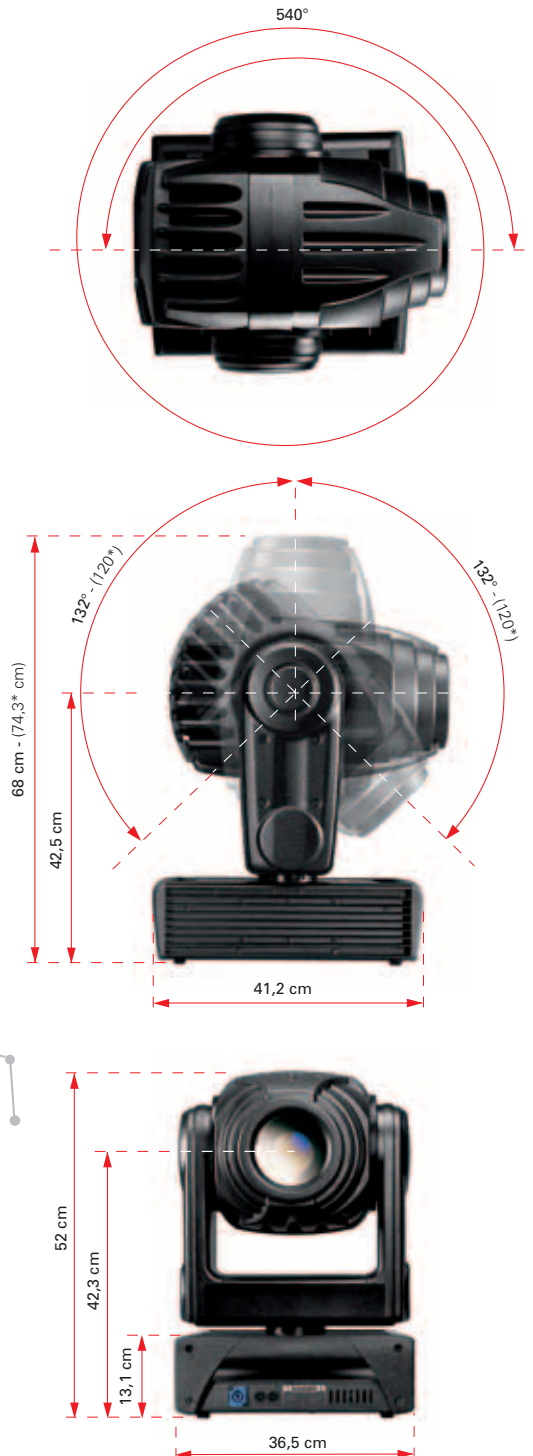

#### 05: Precise rapid movement

Movement precision and speed are ensured by powerful stepper motors. Control is entrusted to a 16-bit system, inertia and acceleration times perfectly distributed and the excellently balanced mechanism guarantees precise smooth movement and absolutely vibration-free high speed (540° PAN in 2.8 seconds and 270° TILT in 1.7 seconds).

#### 06: Automatic repositioning

GIOTTOs 400 are fitted with an automatic fixture repositioning system, which intervenes in the event of impact or if the head is accidentally moved, thus avoiding operators lengthy manual realignment procedure or total reset.



#### 07: Built - In microcomputer and practical display

GIOTTOs 400 are fitted with a micro-computer that enables the fixtures to be personalized in the manner most suited to the type of installation.

It's possible to assign the starting address, set pan and tilt movement, receive data on lamp elapsed time and fixture operating time and run diagnostic checks, controlling all the functions on the built-in display.

Display brightness is adjustable and messages can be flipped through 180° for more flexible use.

### Absolute silent operating and cooling

The **GIOTTOs 400** were designed paying great attention to operating silence, a key priority for theatre and television applications: cooling is via convection. The head movement (pan and tilt) and the fixtures' internal

mechanism (colourchanger, effects, etc.) also have an extremely low noise level. A phonometric test in an anechoic chamber on a **GIOTTO 400** made by Istituto Giordano S.p.A. shows a noise level of 31.8 dB at 1 mt.



09: **Electronic Ballast fitted as standard**

The electronic ballast used by **GIOTTO 400 SERIES** offers countless advantages over traditional electromagnetic ballasts. In terms of performance - steady flicker-free beams and longer lamp life - and practicality: the ballast weighs a lot less and automatically accepts any power supply between 90 and 245 Volts (50/60 Hz).

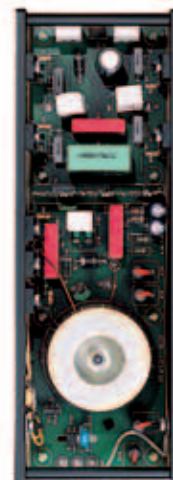

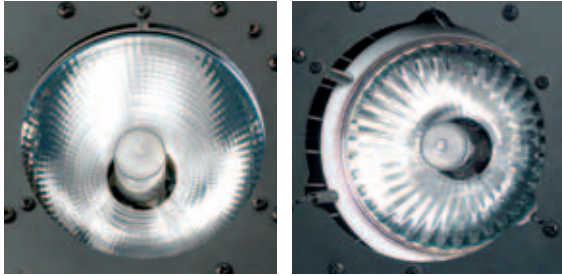

A.

B.

### 10: Optical group

The **GIOTTOs 400** optical group, designed using the most advanced optical software, combines high luminous efficiency with high-quality projection. The MSR 400HR lamp, used along with a glass reflector with a special dichroic finish, projects a uniform, extremely powerful light beam.

GIOTTO SPOT 400 CMY:	12.500	- lux at 5 m. (fig. A)
GIOTTO SPOT 400:	12.000	- lux at 5 m. (fig. B)
GIOTTO PROFILE 400:	4.968,50	- lux at 5 m. (fig. B)
GIOTTO WASH 400:	3.960	- lux at 5 m. (fig. B)

### 11: Variable zoom

The variable zoom, a unique feature in the fixture's class, allows linear beam adjustment maintaining extraordinary intensity.

Between 9° and 18°	- GIOTTO SPOT 400 CMY
Between 9° and 24°	- GIOTTO SPOT 400
Between 16° and 24°	- GIOTTO PROFILE 400
Between 15° and 30°	- GIOTTO WASH 400

### 12: Lamp

**GIOTTOs 400** use a MSR 400HR discharge lamp featuring intense uniform luminous output over the entire spectrum.



13:

### Easy maintenance

The **GIOTTOs 400'** body can be opened very easily and the head easily separated from the base, which, if necessary, can be left mounted in position on the trussing or support structure. All internal components are easily accessible, enabling greatly simplified maintenance and cleaning work. Re-lamping is also very rapid and can be carried out without moving the lampholder.





- 
- A night scene of a concert stage. The stage is illuminated with vibrant red laser lights that create a dense, atmospheric effect. Several beams of light fan out from the stage towards the audience. In the background, there are silhouettes of stage equipment and a few bright spots of light. The foreground shows the dark silhouettes of a large crowd of people, some with their hands raised. The overall mood is energetic and dramatic.
- 1 . G I O T T O S P O T 4 0 0
  - 2 . G I O T T O S P O T 4 0 0 C M Y
  - 3 . G I O T T O P R O F I L E 4 0 0
  - 4 . G I O T T O W A S H 4 0 0



## GIOTTO SPOT 400



## GIOTTO SPOT 400

For years, its use in professional stage lighting applications has candidated it as the leading moving head fixture in its class, as far as performance and inimitable light quality are concerned.

Used in the most important productions at world level, today it is still the favourite hot-strike 400W fixture, thanks to its luminous output (12,000 Lux at 5 metres), reliability and silent running.

**GIOTTO SPOT 400** features motorized zoom (from 9° to 24°), electronic focus, CTO filters, Half CTO UV, linear iris and frost, 2 rotating prisms, a wheel fitted with 8 rotating gobos, 8 colour filters and an effects wheel.

Giotto Spot 400 is available in black, white and silver.

### 01: Wide choice of colours

As well as colour selection, it's also possible to enable some functions with remarkable visual impact, such as running the colour changer in sync with the music or the rainbow effect. Using a colour channel along with the strobe channel, it's also possible to create an "autoshade" effect on the colour, which blacks out projection for a short instant during the colour change.

### 02: Gobos

The gobo group consists in a wheel containing 8 gobos which can be rotated in both directions and are indexable. Changeover from one gobo to another can be done rapidly and directly, or can be blacked out using the "autoshade" function of the strobe/shutter. It's possible to run gobo changes in sync with the music, while the "gobo shake" function offers interesting effects of movement of the projected gobo.

### 03: Customisable effects wheel

The effects wheel can be layered with the gobo wheel and the colour wheel, and a simple replacement/installation system enables it to be freely customized.

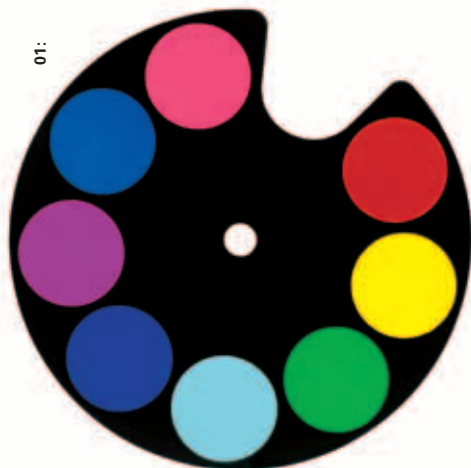

The two conversion filters allow to reduce the lamp's colour temperature, which is 6,000°K under normal working conditions, to 3,200°K (full CTO) and 4,000°K (half CTO), thus obtaining an emission with warmer tones, suited to television and theatre use. Analog colour selection is also available, with which it's possible to obtain two-tone beams of different shades.



The gobos can be rotated clockwise or counter-clockwise and their position can be memorized and kept constant (indexed). Gobo rotation is smooth and linear, with a minimum speed of just 0.1 rpm. The gobo wheel can be set at 8 speeds to obtain a gobo scrolling effect.

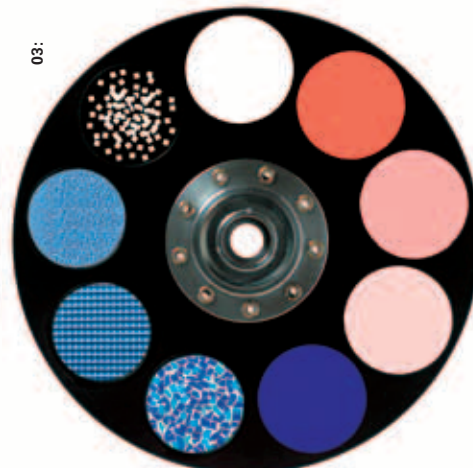

In actual fact, lighting designers can fit **GIOTTO SPOT 400** with 2 colour wheels (a total of 16 colours) and a gobo wheel - the ideal set-up in theatres, or with 2 gobo wheels (a total of 8 rotary + 8 fixed gobos, using the special adaptor) and a colour wheel - for more dynamic creative use, or with other combinations, according to their requirements.

04:

### Variable zoom

The variable zoom, a unique feature in the fixture's class, allows linear beam adjustment between 9° and 24°, maintaining extraordinary intensity.

05:

### Motorized focus

Thanks to the motorized focus, projected images can be kept in focus at any projection angle and from any distance.

06:

### Two rotating prisms

The use of two prisms (4-facet and Comet), rotating at adjustable speed in both directions, enables to create lighting effects with stunning visual impact.

The prism and gobo systems and their respective rotation speeds are totally independent and can be combined freely, obtaining an almost endless range of effects, leaving ample freedom for lighting designers' creativity.

07:

### Variable frost

The variable frost, very useful for colour washes on backdrops, enables to pass from a concentrated beam to a soft wash, gradually diffusing the projected image.

08:

### Linear Iris

The motorized iris group is fast and silent and offers lighting designers precise linear adjustment of beam width, ideal when creating particular visual effects.

09:

### Linear dimmer

The quantity of light emitted by the lens is controlled mechanically by a system made up of two blades which open and close, regulating the light beam fed out with extreme precision and speed.

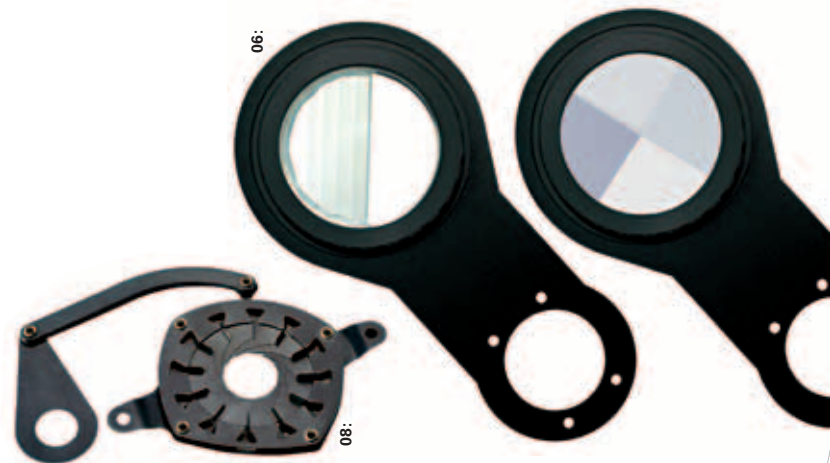
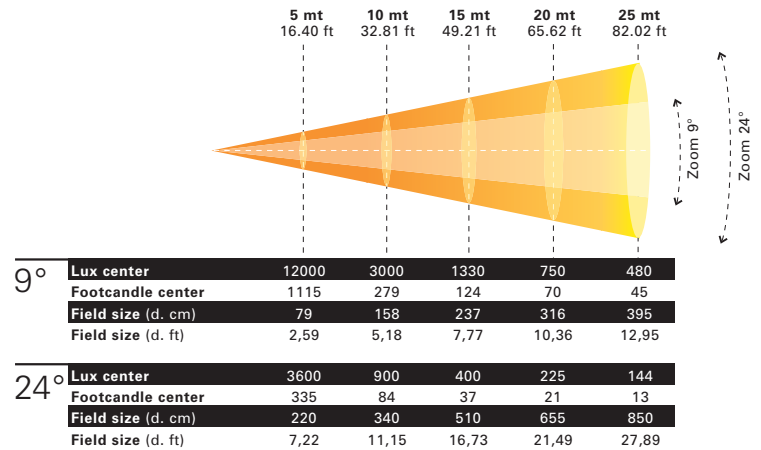

### 10: Strobe-Shutter

The strobe effect is obtained by means of two very light steel blades which open and close at a rate of from 1 to 12 flashes per second and, should it be necessary, allow to block the light beam's output, completely blacking out the fixture.

The system ensures high operating speed and silence, as well as a remarkable flexibility of use, thanks to the possibility of using it along with the dimmer and running the flash in sync with the music.



## GIOTTO SPOT 400 CMY

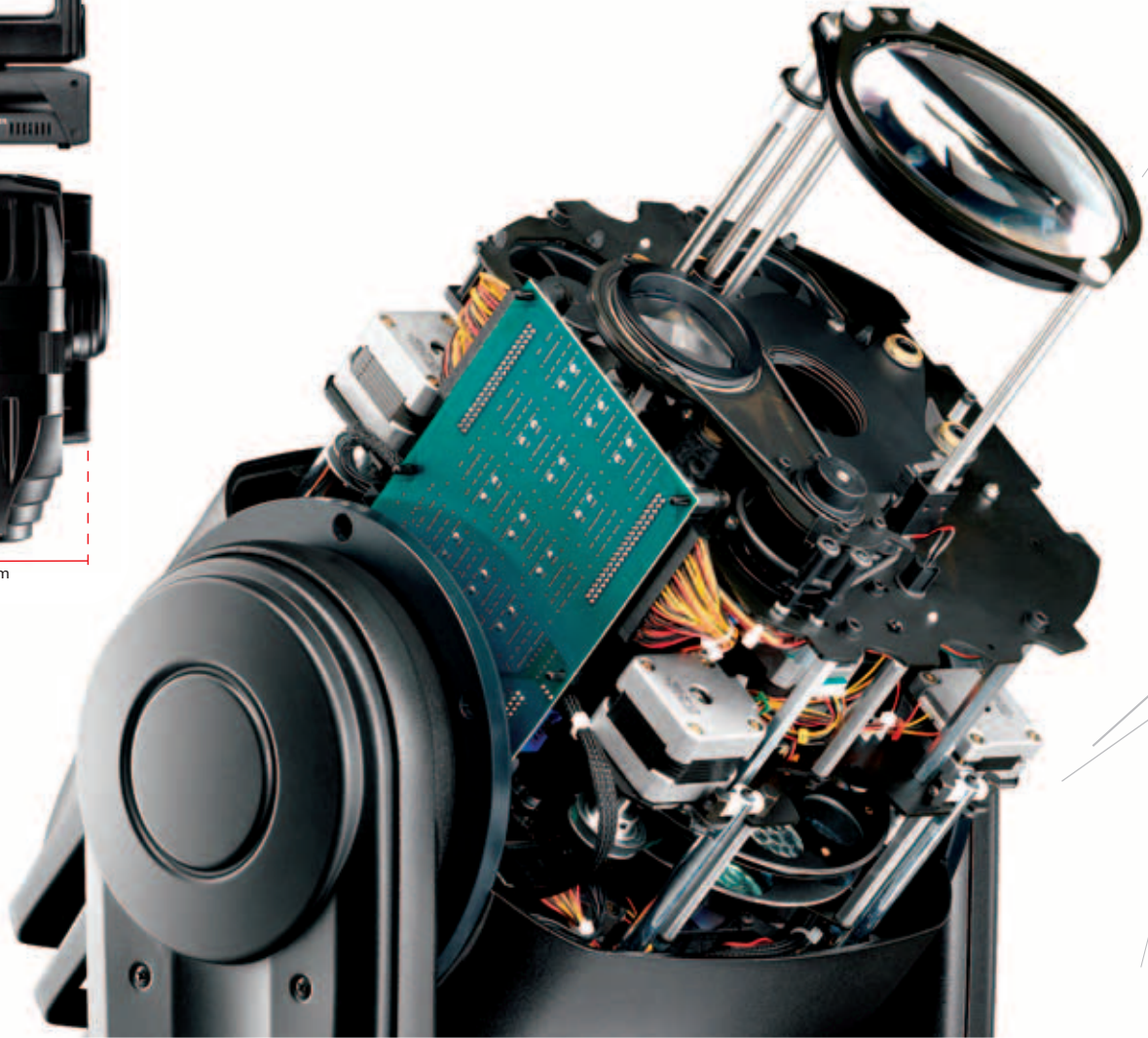

## GIOTTO SPOT 400 CMY

The latest evolution in the GIOTTO 400 line of fixtures. The advanced series of effects and features puts it at the top of the class of moving head fixtures fitted with a 400W lamp. Compared with traditional features, **GIOTTO SPOT 400 CMY** has Cyan Magenta and Yellow colour mixing, to ensure an unlimited number of colours and different shades, Linear CTO, 2 wheels with rotating interchangeable gobos (each

with 8 slots plus white) a 6-colour plus white colour wheel and an easily changed Animation Wheel to create any kind of animated effects.

Silent operation, quality and luminous output also remain as customary strong points for the **GIOTTO SPOT 400 CMY**.

**Giotto Spot 400 CMY** is available in black, white and silver.

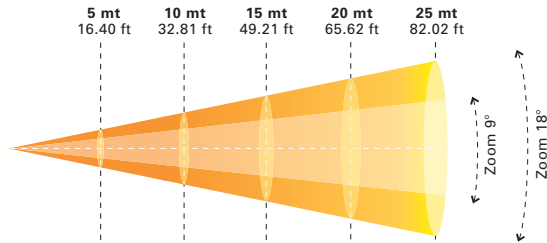

9°	Lux center	12500	3125	1390	780	500
	Footcandle center	1161,70	290,42	129,18	72,49	46,46
	Field size (d. cm)	80	160	240	320	400
	Field size (d. ft)	2,62	5,24	7,87	10,49	13,12

18°	Lux center	3500	875	390	220	140
	Footcandle center	325,27	81,31	36,14	20,32	13,01
	Field size (d. cm)	160	320	480	640	800
	Field size (d. ft)	5,25	10,5	15,75	21	26,25

01:

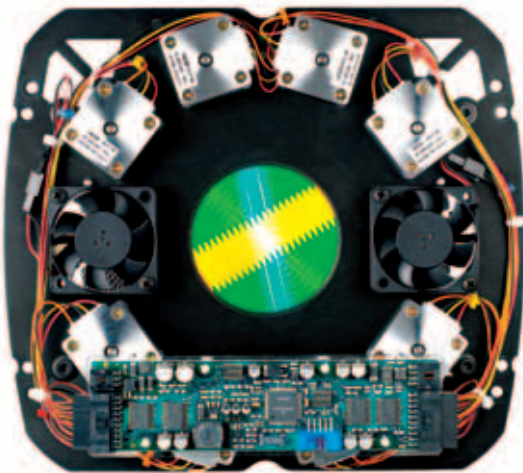

### 01: Colour generation

**GIOTTO SPOT 400 CMY** offers lighting designers an advanced CMY mixing colour system made of 3 palettes, which allows to obtain a uniform light beam and an infinite range of shades, from the most saturated to the softest colours, with efficient control of their tones. The CMY system is integrated by a linear CTO filter and a further colour wheel with 6 colours + white.

02:

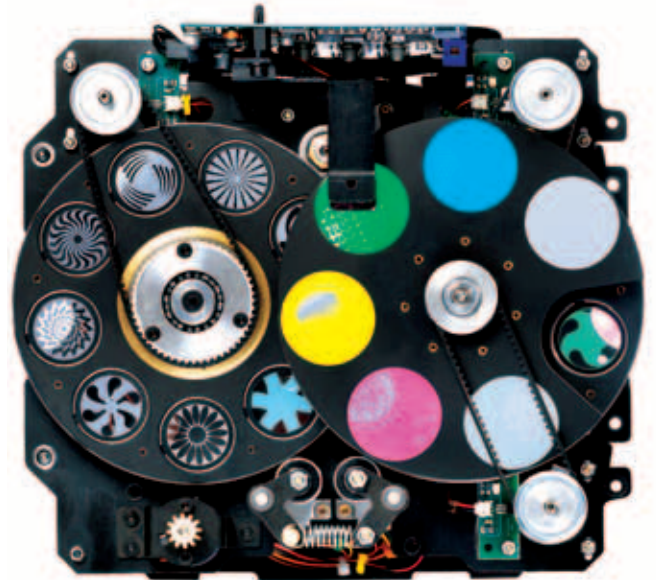

### 02: Gobos

**GIOTTO SPOT 400 CMY** has a comprehensive series of features to create a wide variety of lighting effects: 2 customizable gobo wheels feature 8 rotating indexable gobos + white each, with high-precision 16 bit rotation and indexing. Gobos are easily interchangeable, and can include an almost endless variety of images taken from the wide SGM library or be custom made, in three different types: dichro gobo, metal gobo and glass gobo.



---

**03: Motorized zoom**

The variable zoom, a unique feature in the fixture's class, allows linear beam adjustment between 9° and 18°, maintaining extraordinary intensity.

**04: Motorized focus**

Thanks to the motorized focus, projected images can be kept in focus at any projection angle and from any distance.

---

---

**05: Variable frost**

The variable frost, very useful for colour washes on backdrops, enables to pass from a concentrated beam to a soft wash, gradually diffusing the projected image.

**06: Linear iris**

The motorized iris group is fast and silent and offers lighting designers precise linear adjustment of beam width, ideal when creating particular visual effects.

---

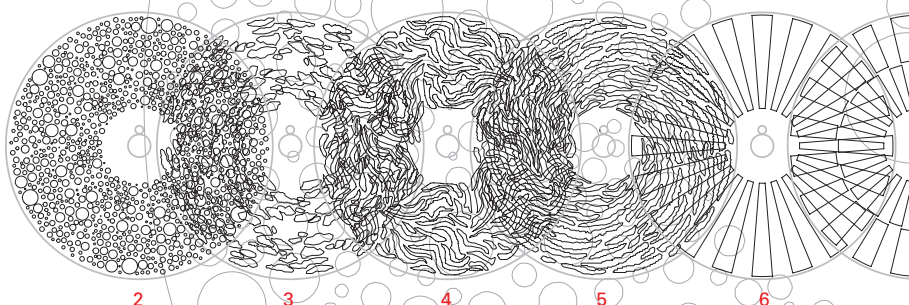
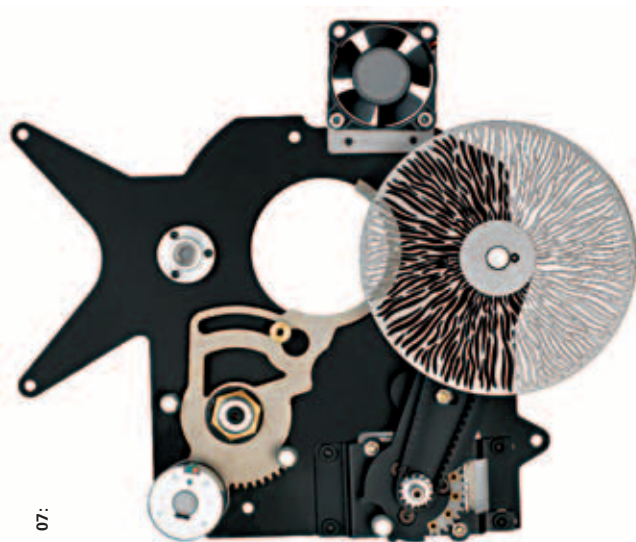

---

**07: Animation wheel**

An animation wheel (interchangeable) lets you project a series of eye-catching patterns (flames, clouds, bubbles, and other shapes) rotating clockwise or counterclockwise at variable speeds.

---

**08: Rotating prism**

The use of a 4-facet prism, rotating at adjustable speed in both directions, enables to create lighting effects with stunning visual impact. The prism and gobo systems and their respective rotation speeds are totally independent and can be combined freely, obtaining an almost endless range of effects, leaving ample freedom for lighting designers' creativity.

---





## GIOTTO PROFILE 400

**GIOTTO PROFILE 400** was designed and manufactured specifically for top-level professional applications in the theatre and television field, where it is necessary to be able to shape light beams freely and precisely, with bright well-defined edges. **GIOTTO PROFILE 400's** built-in beam shaping module is fitted with 4 blades, each of which can be independently controlled as far as insertion and inclination are concerned. In fact, each blade can be gradually inserted

into the light beam until it is completely blacked out. The  $\pm 45^\circ$  rotation of each blade on its axis enables to form any 4-sided or triangular shape extremely easily.

**GIOTTO PROFILE 400** also features linear Frost, CTO Filter, effects wheel and 6-slot plus white colour wheel as well as Focus and electronic Zoom between  $16^\circ$  and  $24^\circ$ .

**GIOTTO PROFILE 400** is available in black, white and silver.

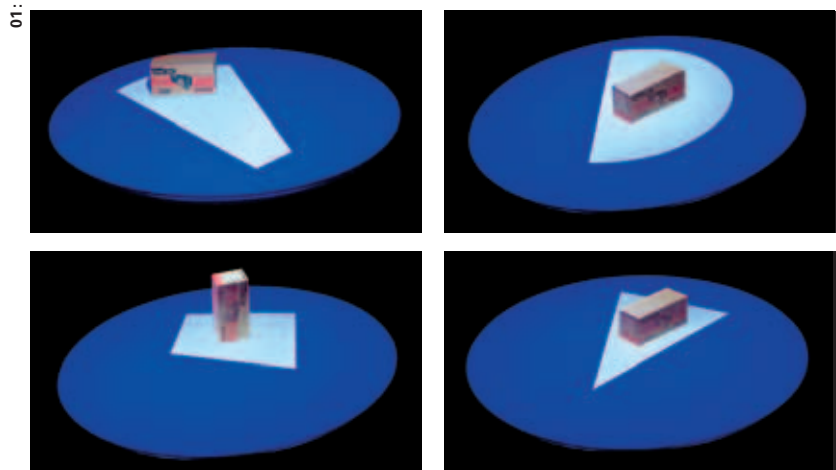
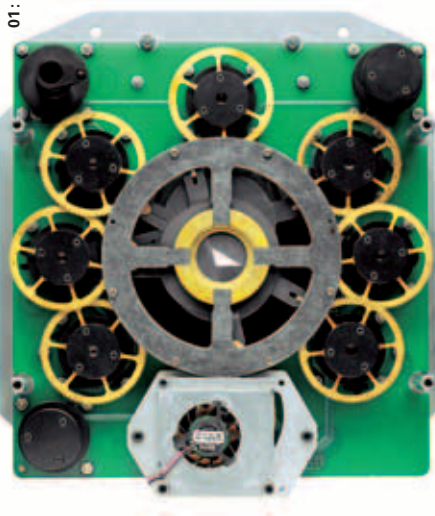

### 01: Built-in beam shaping module

The Giotto Profile 400 is fitted with an exclusive internal 4-blade DMX-controlled shaper particularly suited to theatrical and television use, which enables light beams to be modeled, forming any regular or irregular 3-sided or 4-sided shapes.

The shaper, used along with motorized focus, customizable colour wheel, customizable effect wheel, CTO filter and linear frost enables a countless variety of lighting effects to be created.

### 02: Variable frost

The variable frost, very useful for colour washes on backdrops, enables to pass from a concentrated beam to a soft wash, gradually diffusing the projected image.

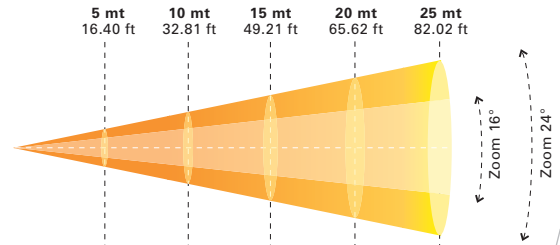

	5 mt 16.40 ft	10 mt 32.81 ft	15 mt 49.21 ft	20 mt 65.62 ft	25 mt 82.02 ft
<b>16°</b>					
<b>Lux center</b>	4968,50	1242,60	551,95	310,65	199,50
<b>Footcandle center</b>	463,05	115,81	51,44	28,95	18,59
<b>Field size (d. cm)</b>	145	290	435	580	725
<b>Field size (d. ft)</b>	4,75	9,51	14,27	19	23,8
<b>24°</b>					
<b>Lux center</b>	2660,00	665,00	295,45	166,25	106,40
<b>Footcandle center</b>	247,90	61,98	27,53	15,49	9,92
<b>Field size (d. cm)</b>	217	434	651	868	1085
<b>Field size (d. ft)</b>	7,12	14,24	21,36	28,5	35,6

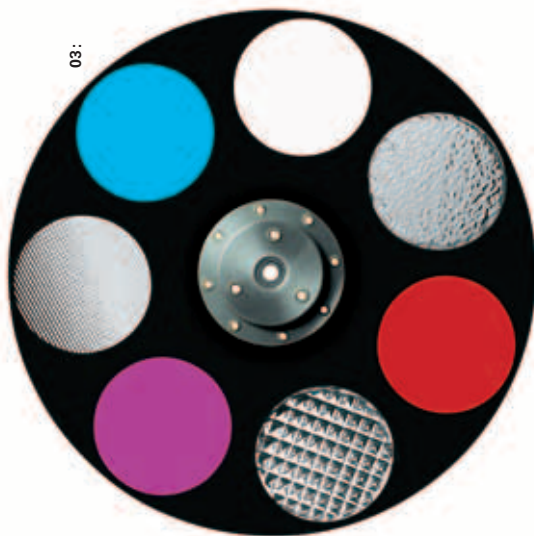

### 03: Colour wheel - Effect wheel

**GIOTTO PROFILE 400** is fitted with an effect wheel comprising 3 dichroic filters and 3 glass gobos, and a colour wheel with 6 dichroic filters. As well as colour selection, it's also possible to enable some functions with remarkable visual impact, such as running the colour changer in sync with the music or the rainbow effect. Using a colour channel along with the strobe channel, it's also possible to create an "autoshade" effect on the colour, which blacks out projection for a short instant during the colour change.

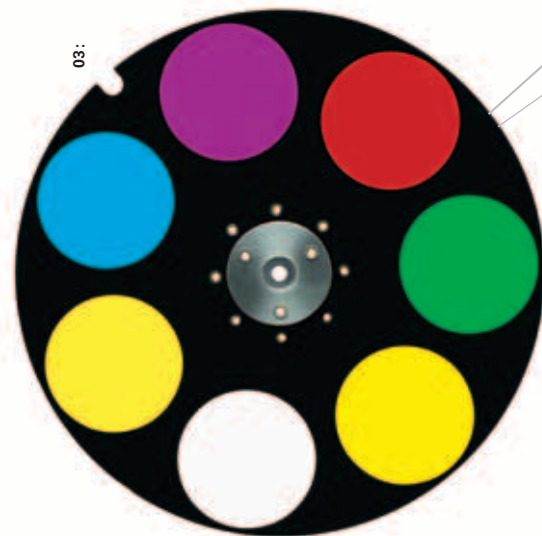

### 04: Motorized zoom

The motorized 16°- 24° zoom gives beam angles otherwise only obtainable with more expensive fixtures.

### 05: Motorized focus

Thanks to the motorized focus, projected images can be kept in focus at any projection angle and from any distance.





## GIOTTO WASH 400

The GIOTTO 400 series wouldn't have been complete without a Wash fixture, a must whenever delicate uniform lighting is required. The advanced CYM colour mixing system. Along with a linear CTO filter, enables absolutely any shade of colour to be obtained. A further 7-slot plus white colour wheel also gives the possibility of generating all the deepest colours.

**GIOTTO WASH 400** features a built-in electronic beam shaper

with two blades that can be moved from 0 to 180°, ideal in theatrical applications, for high-precision lighting of specific areas of the set.

Adjustable (15° to 30°) zoom, hot restrike and silent running complete **GIOTTO WASH 400's** operating features.

**Giotto Wash 400** is available in black, white and silver.

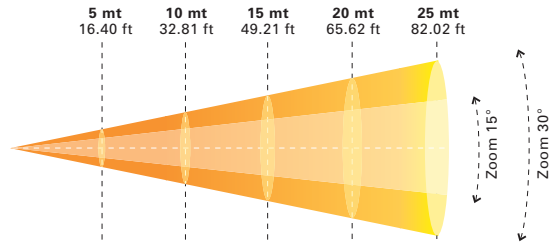

15°	Lux center	12000	3000	1330	750	480
	Footcandle center	1115	279	124	70	45
	Field size (d. cm)	132	265	398	530	663
	Field size (d. ft)	4,33	8,69	13,05	17,38	21,75
30°	Lux center	3000	750	333	188	120
	Footcandle center	278	70	31	17	11
	Field size (d. cm)	268	536	804	1072	1340
	Field size (d. ft)	8,79	17,58	26,37	35,17	43,96

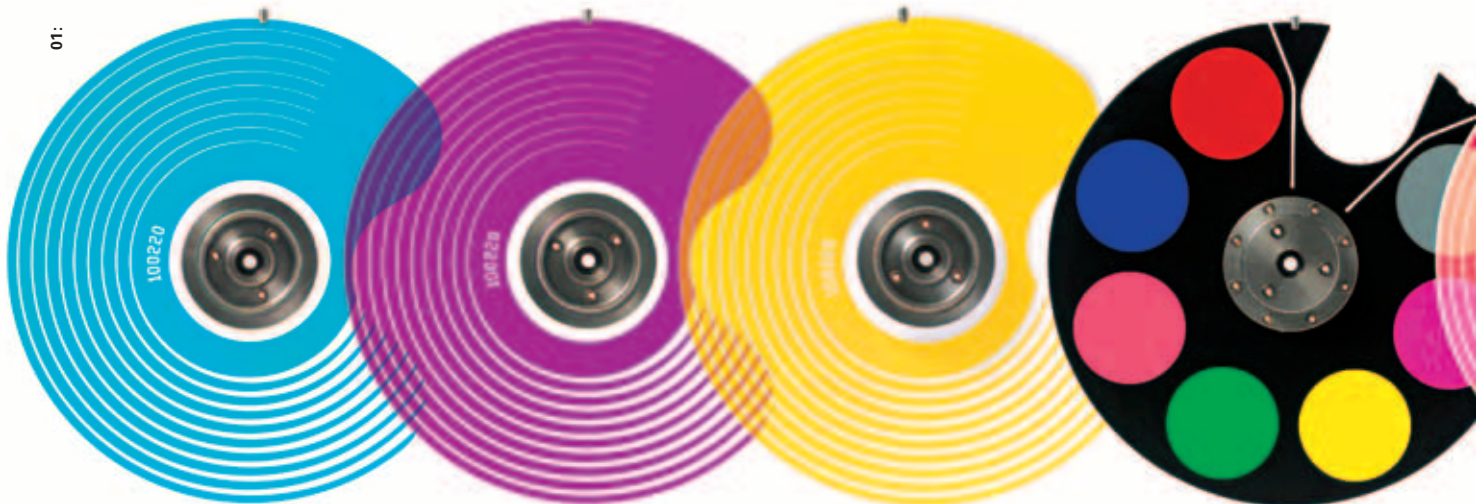

### 01: Colour generation

**GIOTTO WASH 400** contains an advanced 3-wheel CMY colour mixing system, integrated by a fourth wheel with 5 colours + amber, which can be layered with the 3-colour mixing. A simple system for replacing the dichroic filters enables to rapidly personalize the colour wheel, adapting it to meet different lighting requirements.

### 02: Linear CTO

**GIOTTO WASH 400** is fitted with a linear CTO filter which allows to gradually and precisely lower the colour temperature from 6,000°K to 3,200°K (full CTO), ideal for television applications.

The combination of colour system, colour wheel and linear CTO filter enables to obtain an endless range of colours, from the most saturated to the softest hues, with efficient control of their tones.

### 03: Linear dimmer

The amount of light emitted by the lens is controlled mechanically by a wheel, which smoothly and gradually adjusts the light beam fed out.



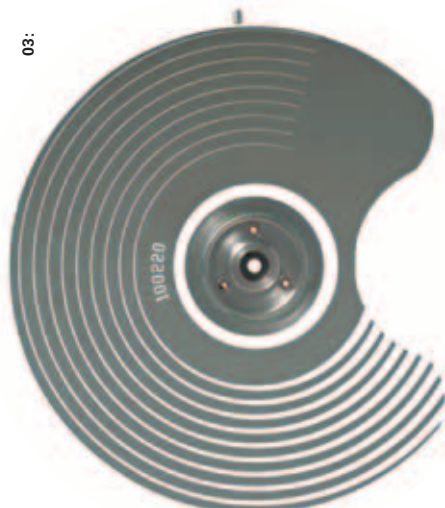
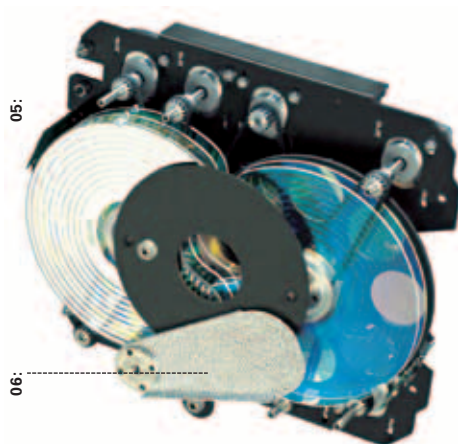

---

**04: Variable zoom**

The variable zoom, a unique feature in the fixture's class, allows linear beam adjustment between 15° and 30°, maintaining extraordinary intensity.

**05: Optical group**

**GIOTTO WASH 400** generates soft, evenly diffused light, thanks to the use of a 400W discharge lamp along with a special reflector with a dichroic finish and a system consisting in condenser lens + 130 mm. plano-convex lens with anti-halo treatment.

**06: Strobe/shutter**

The strobe effect is obtained by means of a very light aluminium blade which opens and closes the lens at a rate of from 1 to 12 flashes per second and, should it be necessary, allows to block the light beam's output, completely blacking out the fixture.

The system ensures high operating speed and silence, as well as a remarkable flexibility of use, thanks to the possibility of using it along with the dimmer and running the flash in sync with the music.

**07: Built-in shutters**

The built - in shutter system, designed for theatre and television use, enables to shape the light beam. The blades' opening/closing and 180° rotation of the entire group are controlled via DMX.

---







### Handles

**GIOTTOs 400** are powerful and versatile, yet compact and light weight; in fact, the fixture can be easily transported and installed by a single operator, thanks to the practical handles.



### ACCESSORIES

#### 01: Light Dome

Cover for outdoor use with **GIOTTO 400 SPOT, WASH** and **PROFILE** fixtures.

The Dome is in highly transparent heat-resistant polycarbonate with a built-in ventilation system and grey ABS body. • Tamper-proof system. • Power requirements 220V AC, 50/60Hz, 30W.



#### 02: Flight case

These sturdy flight cases were specially studied and designed for transporting and storing fixtures, ensuring total protection against impact. The flight cases are available in a double version, (with castors fitted as standard) and a single version (castors on request) and are equipped with internal accessory compartments.



03: **Mounting clamps**

The "Fast-Lock" clamps mounted as standard are manufactured in aluminium and designed to guarantee secure clamping to truss tubes with a diameter of between 38 and 50 mm. On the underside of Giotto fixtures, there are 8 slots for fitting the clamps, which can be positioned horizontally and vertically.

## GIOTTO SPOT 400

## GIOTTO SPOT 400 CMY

## GIOTTO PROFILE 400

## GIOTTO WASH 400

LAMP	MSR 400HR lamp (6.000°K) Average lamp life: 750 H Hot restrike Remote Lamp on/off via DMX Lamp power reduction in the event of overheating Lamp elapsed time and ignition counters 50% lamp power after 7 sec. with shutter or dimmer at 0	MSR 400HR lamp (6.000°K) Average lamp life: 750 H Hot restrike Remote Lamp on/off via DMX Lamp power reduction in the event of overheating Lamp elapsed time and ignition counters 50% lamp power after 7 sec. with shutter or dimmer at 0	MSR 400HR lamp (6.000°K) Average lamp life: 750 H Hot restrike Remote Lamp on/off via DMX Lamp power reduction in the event of overheating Lamp elapsed time and ignition counters 50% lamp power after 7 sec. with shutter or dimmer at 0	MSR 400HR lamp (6.000 K) Average lamp life: 750 H Hot restrike Remote Lamp on/off via DMX Lamp power reduction in the event of overheating Lamp elapsed time and ignition counters 50% lamp power after 7 sec. with shutter or dimmer at 0
COLOUR	Customizable colour wheel with 8 colours + white 3,200°K colour conversion filter (full CTO) 4,000°K colour conversion filter (half CTO) 2-tone beams	Advanced CMY colour mixing Customizable colour wheel: 6 colours + white. Linear CTO filter	Customizable colour wheel 3,200°K colour conversion filter (full CTO)	Advanced CMY colour mixing Customizable colour wheel with 7 colours + white Linear colour conversion filter
GOBO	4 fixed gobos (effect wheel) 8 rotating indexable gobos	2 customizable gobo wheels: 8 rotating indexable gobos (16-bit). Gobo change in sync with music and/or w. blackout. Animation wheel (interchangeable)		
EFFECTS	Linear frost Customizable effect wheel Colour change in sync with music and/or with blackout. Rainbow color UV light 2 rotating prisms (4 facets and 'Comet') Linear iris diaphragm	Linear frost 2-tone beams Colour change in sync with music and/or with blackout Rainbow colour UV light 1 rotating prism (4 facets) Linear iris diaphragm	Linear frost Customizable effect wheel Colour change in sync with music and/or with blackout Rainbow color 4-leaf beam shaper, controlled via DMX	Internal shutters can be rotated through 180° Rainbow color UV light
OPTICS	Motorized zoom 9°-24° Motorized focus	Motorized zoom 9°-18° Motorized focus	Motorized zoom 16°-24° Motorized focus	Motorized zoom 15°-30°
DIMMER SHUTTER STROBE	Linear dimmer Shutter Strobe 1-12 flashes per second, also with music sync.	Linear dimmer Shutter Strobe 1-12 flashes per second, also with music sync.	Linear dimmer Shutter Strobe 1-12 flashes per second, also with music sync.	Linear dimmer Shutter Strobe 1-12 flashes per second, also with music sync.
PAN/TILT	Pan 540° 2.8 sec. Tilt 270° 1.7 sec. 8/16 bit resolution Automatic Pan/Tilt repositioning	Pan 540° 2.8 sec. Tilt 240° 1.7 sec. 8/16 bit resolution Automatic Pan/Tilt repositioning	Pan 540° 2.8 sec. Tilt 270° 1.7 sec. 8/16 bit resolution Automatic Pan/Tilt repositioning	Pan 540° 2.8 sec. Tilt 270° 1.7 sec. 8/16 bit resolution Automatic Pan/Tilt repositioning
INPUT	DMX 512 - RS 232 input signal 23 DMX channels	DMX 512 or RS 232 input signal 33 DMX channels	DMX 512 - RS 232 input signal 27 DMX channels	DMX 512 - RS 232 input signal 18 DMX channels
SET UP	Settings via on-board microcomputer viewable on display Display "flip" function 180° rotation Adjustable display brightness Fixture running time counter	Settings via on-board microcomputer viewable on display Display "flip" function 180° rotation Adjustable display brightness Fixture running time counter	Settings via on-board microcomputer viewable on display Display "flip" function 180° rotation Adjustable display brightness Fixture running time counter	Settings via on-board microcomputer viewable on display Display "flip" function 180° rotation Adjustable display brightness Fixture running time counter
POWER	Power supply (universal 90/245V 50/60Hz) Electronic Ballast (universal 90/245V 50/60Hz)	Power supply (universal 90/245V 50/60Hz) Electronic Ballast	Power supply (universal 90/245V 50/60Hz) Electronic Ballast (universal 90/245V 50/60Hz)	Power supply (universal 90/245V 50/60Hz) Electronic Ballast (universal 90/245V 50/60Hz)
CONSUM.	Max consumption: 600 W Automatic energy saving in the event of blackout use	Max consumption: 700 W	Max consumption: 600 W Automatic energy saving in the event of blackout use	Max consumption: 600 W Automatic energy saving in the event of blackout use
	<b>(HxWxD):</b> 68,1 x 36,5 x 41,2 cm <b>WEIGHT:</b> 24,8 Kg <b>CODE:</b> 020-2415 (black) 020-2417 (white) 020-2421 (silver)	<b>(HxWxD):</b> 74,3 x 36,5 x 41,2 cm <b>WEIGHT:</b> 33 Kg <b>CODE:</b> 020-2413 (black) 020-2424 (white) 020-2425 (silver)	<b>(HxWxD):</b> 68,1 x 36,5 x 41,2 cm <b>WEIGHT:</b> 24,8 Kg <b>CODE:</b> 020-2450 (black) 020-2449 (white) 020-2423 (silver)	<b>(HxWxD):</b> 68,1 x 36,5 x 41,2 cm <b>WEIGHT:</b> 24,8 Kg <b>CODE:</b> 020-2419 (black) 020-2418 (white) 020-2422 (silver)

	<b>GIOTTO SPOT 400</b>	<b>GIOTTO SPOT 400 CMY</b>	<b>GIOTTO PROFILE 400</b>	<b>GIOTTO WASH 400</b>	
<b>Ch1</b>	PAN (8 BIT) MSB	PAN (8 BIT) MSB	PAN (8 BIT) MSB	PAN (8 BIT) MSB	<b>Ch1</b>
<b>Ch2</b>	PAN (16 BIT) LSB	PAN (16 BIT) LSB	PAN (16 BIT) LSB	PAN (16 BIT) LSB	<b>Ch2</b>
<b>Ch3</b>	TILT (8 BIT) MSB	TILT (8 BIT) MSB	TILT (8 BIT) MSB	TILT (8 BIT) MSB	<b>Ch3</b>
<b>Ch4</b>	TILT (16 BIT) LSB	TILT (16 BIT) LSB	TILT (16 BIT) LSB	TILT (16 BIT) LSB	<b>Ch4</b>
<b>Ch5</b>	IRIS	IRIS	COLOUR CONVERSION FILTER	COLOURS	<b>Ch5</b>
<b>Ch6</b>	COLOURS	COLOURS	COLOUR WHEEL	CYAN	<b>Ch6</b>
<b>Ch7</b>	GOBO	GOBO 1	EFFECT WHEEL	MAGENTA	<b>Ch7</b>
<b>Ch8</b>	SHUTTER / STROBE	SHUTTER / STROBE	SHUTTER / STROBE	YELLOW	<b>Ch8</b>
<b>Ch9</b>	DIMMER	DIMMER	DIMMER	DIMMER	<b>Ch9</b>
<b>Ch10</b>	GOBO ROTATION	GOBO 1 ROTATION (MSB)	BLADE 1 OPENING	SHUTTER / STROBE	<b>Ch10</b>
<b>Ch11</b>	PRISM	PRISM / FLATTENER	BLADE 1 ROTATION	ZOOM	<b>Ch11</b>
<b>Ch12</b>	PRISM ROTATION	PRISM ROTATION	BLADE 2 OPENING	M SPEED	<b>Ch12</b>
<b>Ch13</b>	FOCUS	FOCUS	BLADE 2 ROTATION	RESET / LAMP	<b>Ch13</b>
<b>Ch14</b>	ZOOM	ZOOM	BLADE 3 OPENING	CTO	<b>Ch14</b>
<b>Ch15</b>	EFFECT WHEEL	ANIMATION WHEEL	BLADE 3 ROTATION	COLOUR MAP	<b>Ch15</b>
<b>Ch16</b>	FROST	FROST	BLADE 4 OPENING	MACRO	<b>Ch16</b>
<b>Ch17</b>	M SPEED	M SPEED	BLADE 4 ROTATION	SHUTTER OPENING	<b>Ch17</b>
<b>Ch18</b>	RESET / LAMP	RESET / LAMP	RESET / LAMP	SHUTTER ROTATION	<b>Ch18</b>
<b>Ch19</b>	GOBO SHAKE	GOBO 1 SHAKE	M SPEED		<b>Ch19</b>
<b>Ch20</b>	COLOUR MODE	COLOUR MODE	FOCUS		<b>Ch20</b>
<b>Ch21</b>	GOBO ROTATION MODE	GOBO ROTATION MODE	ZOOM		<b>Ch21</b>
<b>Ch22</b>	MACRO	MACRO	FROST		<b>Ch22</b>
<b>Ch23</b>	FINE INDEXABLE GOBO (LSB)	GOBO 1 ROTATION (LSB)	COLOUR MODE		<b>Ch23</b>
<b>Ch24</b>		GOBO 2	EFFECT MODE		<b>Ch24</b>
<b>Ch25</b>		GOBO 2 ROTATION (MSB)	SHAKE EFFECT 1		<b>Ch25</b>
<b>Ch26</b>		GOBO 2 ROTATION (LSB)	SHAKE EFFECT 2		<b>Ch26</b>
<b>Ch27</b>		GOBO 2 ROTATION MODE	MACRO		<b>Ch27</b>
<b>Ch28</b>		GOBO 2 SHAKE			<b>Ch28</b>
<b>Ch29</b>		ANIMATION WHEEL ROTATION			<b>Ch29</b>
<b>Ch30</b>		CYAN			<b>Ch30</b>
<b>Ch31</b>		MAGENTA			<b>Ch31</b>
<b>Ch32</b>		YELLOW			<b>Ch32</b>
<b>Ch33</b>		CTO			<b>Ch33</b>

---

**GIOTTO SPOT 400**
**Gobo Wheel (2101143)**

- 0. Empty
- 1. D3D0001 METAL
- 2. D7F0001 DICHR0
- 3. D3D0002 METAL
- 4. D4F0003 DICHR0
- 5. D3D0003 METAL
- 6. D4F0002 DICHR0
- 7. D4F0004 DICHR0
- 8. D4F0001 DICHR0

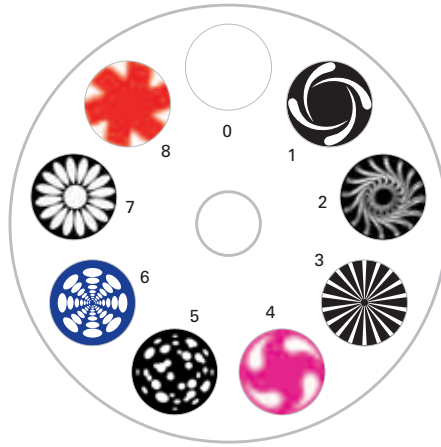
**Effects Wheel (2101144)**

- 0. Empty
- 1. D3D0004 METAL
- 2. D8D0001 GLASS
- 3. D8D0002 GLASS
- 4. D9D0001 GLASS
- 5. F040170 Wood Filter
- 6. F040169 Filter Half CTO
- 7. F040168 Filter Full CTO
- 8. F040161 Amber Filter

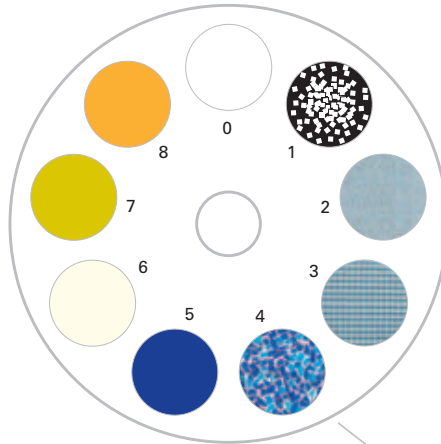

---

**GIOTTO PROFILE 400**
**Colour Wheel (2101113)**

- 0. Empty
- 1. F040158 Cyan
- 2. D8C0003 GLASS
- 3. F040154 Rose
- 4. D8C0001 GLASS
- 5. F040159 Orange
- 6. D8C0002 GLASS

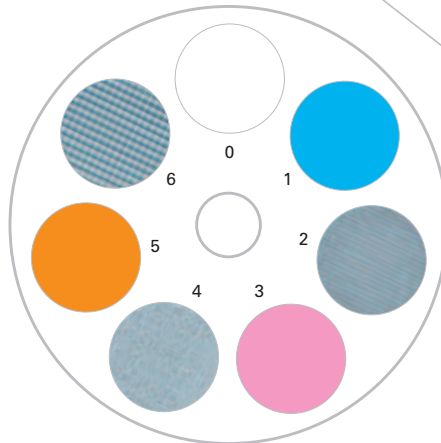



## GIOTTO SPOT 400 CMY

### Gobo Wheel 1 (2101123)

- 0. Empty
- 1. D4F0001 DICHRO
- 2. D4F0004 DICHRO
- 3. D4F0112 DICHRO
- 4. D7F0035 DICHRO
- 5. D7F0017 DICHRO
- 6. D4F0113 DICHRO
- 7. D4F0110 DICHRO
- 8. D4F0109 DICHRO

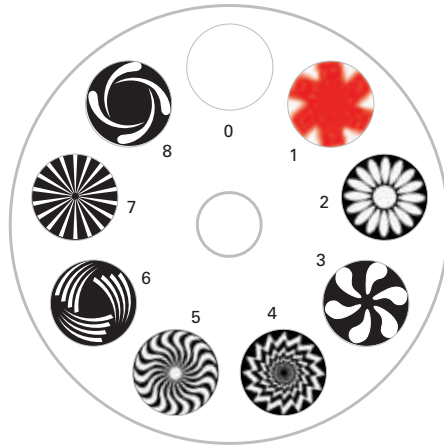

### Gobo Wheel 2 (2101124)

- 0. Empty
- 1. D4F0111 DICHRO
- 2. D8F0010 GLASS
- 3. D9F0001 GLASS
- 4. D4F0003 DICHRO
- 5. D4F0112 DICHRO
- 6. D8F0008 GLASS
- 7. D8F0012 GLASS
- 8. D8F0002 GLASS

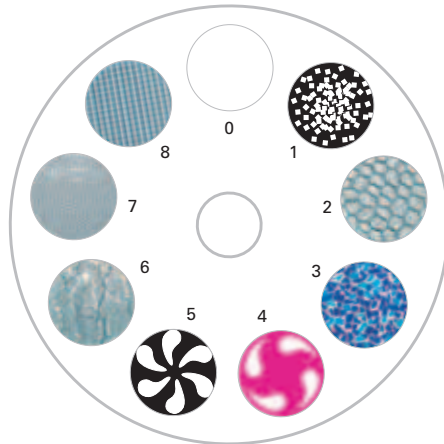

### Animation Wheel

- 1. D2N0001  
D.100 "FUOCO" (serial)
- 2. D2N0002  
D.100 "BOLLE" (optional)
- 3. D2N0003  
D.100 "NUVOLE" (optional)
- 4. D2N0007  
D.100 "CRAZY BLAZE" (optional)
- 5. D2N0004  
D.100 "NUVOLE-2" (optional)
- 6. D2N0005  
D.100 "SETTORI" (optional)
- 7. D2N0006  
D.100 "SETTORI-2" (optional)

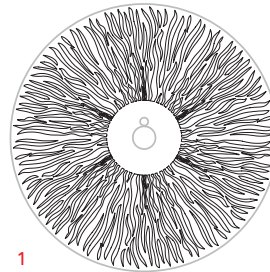

1



5

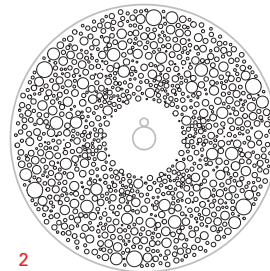

2

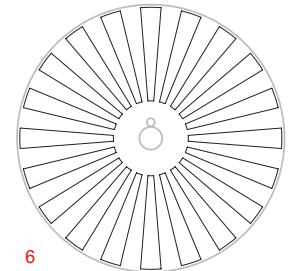

6

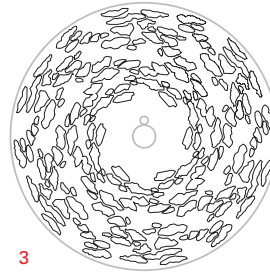

3

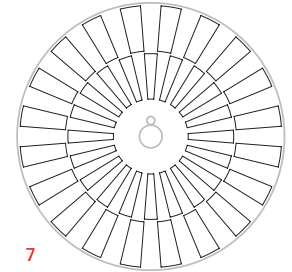

7

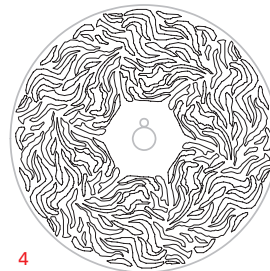

4

GIOTTO SPOT 400 CMY

GIOTTO SPOT 400

GIOTTO PROFILE 400

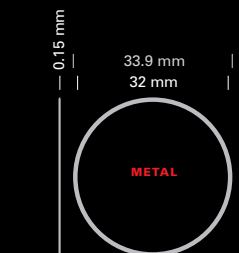
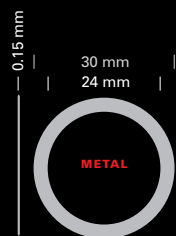
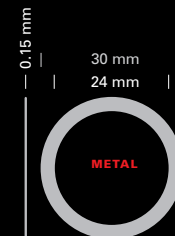
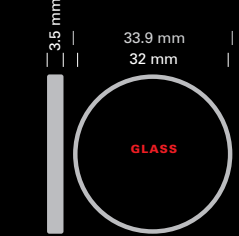
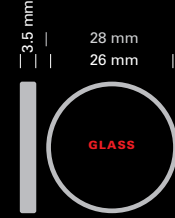
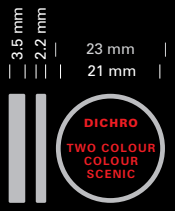
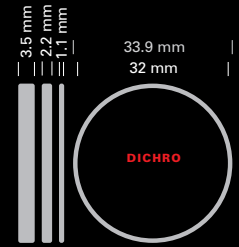

- METAL
- DICHRO GRAYSCALE
- DICHRO 1 COLOUR
- DICHRO 2 COLOUR
- DICHRO COLOUR SCENIC
- GLASS TEXTURE
- GLASS CRUSHED
- ANIMATION WHEEL

R. gobo Gobo W.	R. effetti Effects W.
D	D
F	D
F	D
F (2)	D
F (2)	D
F (2)	D
F (2)	D
N	

R. gobo Gobo W.	R. effetti Effects W.
D	D
F	D
F	D
F (2)	D
F (2)	D
F (2)	D
F (2)	D

M (5)
C (5)
C (5)
C
C
C

(1) Bezel - A040139 - Supporto | (2) Bezel - A040287 - Supporto | (3) Bezel - A040115 - Supporto |  
(4) Bezel - A040036 - Supporto | (5) Ring - M040150 - Anello

Gobos are easily interchangeable, and can include a large number of images taken from the wide SGM library or be custom made, in three different types: DICHRO GOBO, METAL GOBO and GLASS GOBO.



MAKE

TRADE

FAIR

.COM



**PRO LINE**  
professional show lighting

GB A000423

PROFESSIONAL MOVING HEADS

SGM TECHNOLOGY FOR LIGHTING SPA  
VIA PIO LA TORRE, 1 - 61010 TAVULLIA (PU), ITALY  
TEL. +39 0721 476477 - FAX +39 0721 476170  
www.sgm.it - info@sgm.it

OPERATIONAL VERSATILITY IS THE STRONG POINT OF GIOTTO 400: COMPACT BUT CAPABLE OF GREAT PERFORMANCE, GIOTTO 400 HAVE ALL THE FUNCTIONS THAT MAKE LIGHTING OPS' AND DESIGNERS' WORK MORE PRODUCTIVE, MORE CREATIVE AND EASIER. GIOTTO 400 ARE FITTED WITH A 400W DISCHARGE LAMP, USED ALONG WITH AN OPTICAL GROUP THAT GIVES EXTRAORDINARY LUMINOUS POWER. THE ELECTRONIC BALLAST ENSURES BRIGHT FLICKER-FREE LIGHT. THE MOTORIZED ZOOM GIVES BEAM ANGLES OTHERWISE ONLY OBTAINABLE WITH MORE EXPENSIVE FIXTURES. MOVEMENT, INTERNAL MECHANISM AND VENTILATION GUARANTEE ABSOLUTE SILENCE, IDEAL FOR THEATRE AND TELEVISION USE.

**SGM**<sup>®</sup>  
Technology for Lighting

**Distributor:**

  
**Techni-Lux**  
www.techni-lux.com

Phone: 407-857-8770

Fax: 407-857-8771

Email: sales@techni-lux.com